

H. T. KINGSBURY.

TOY BANK.

Application filed Sept. 21, 1901. Renewed June 4, 1902.)

(No Model.)

2 Sheets—Sheet 1.

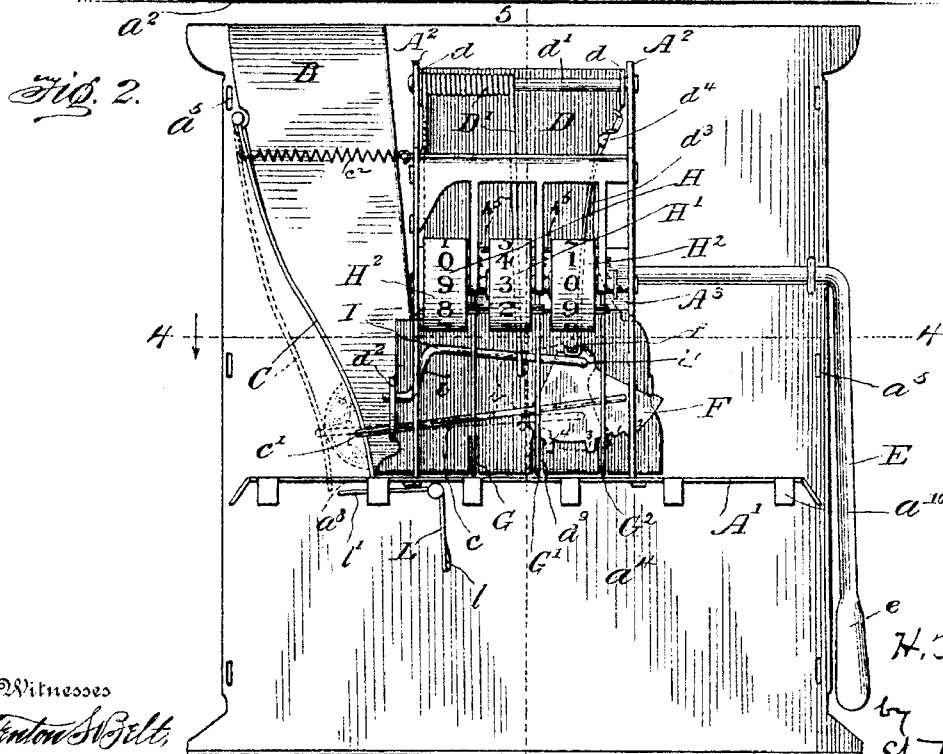
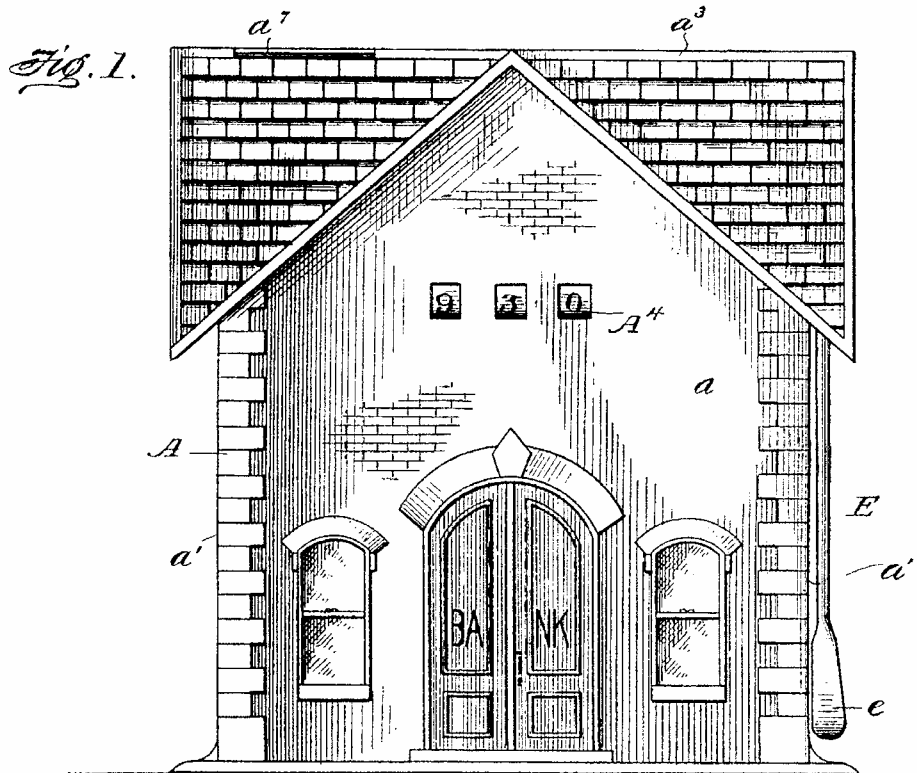

Witnesses
Anton Stelt,
Albert Popkine

Inventor
H. S. Kingsbury
 by
Stewart & Freedy
 Attorneys

H. T. KINGSBURY.
TOY BANK.

(Application filed Sept. 21, 1901. Renewed June 4, 1902.)

(No Model.)

2 Sheets—Sheet 2.

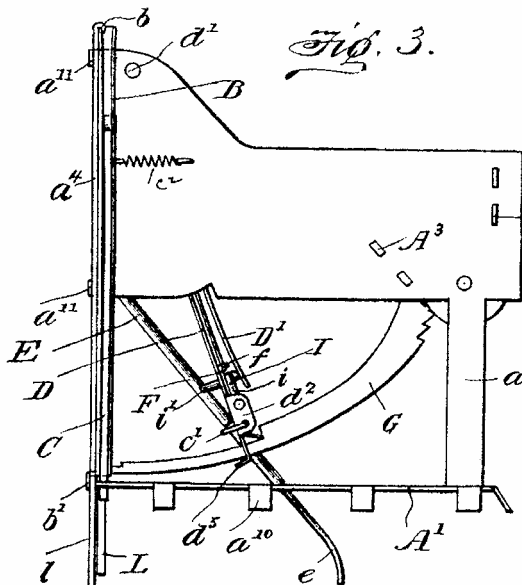

Fig. 3.

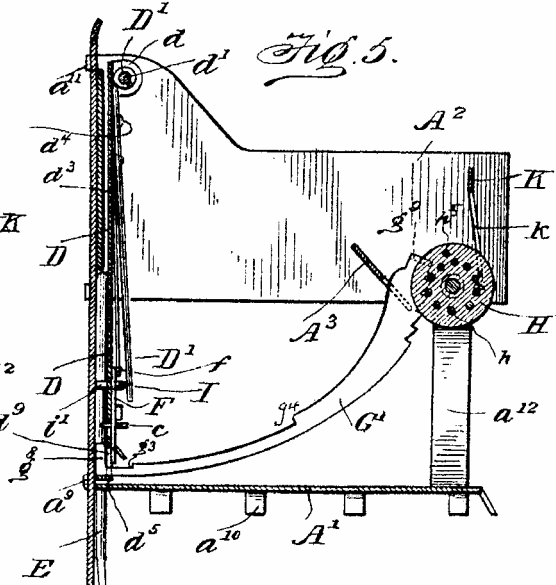

Fig. 5.

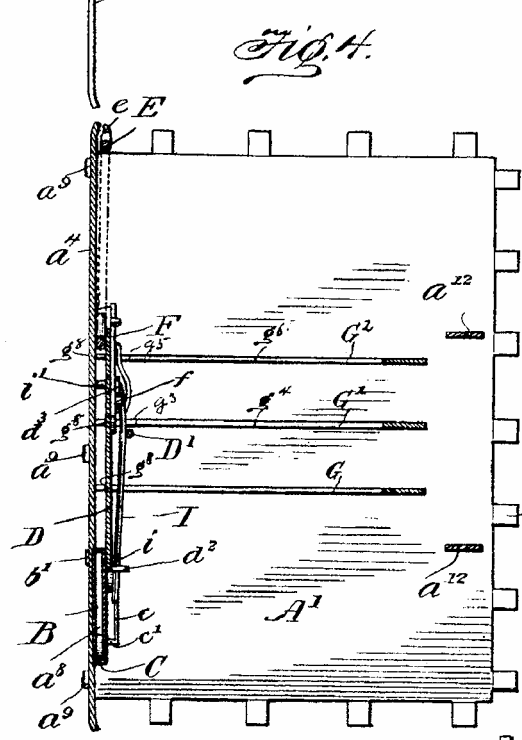

Fig. 4.



Fig. 6.

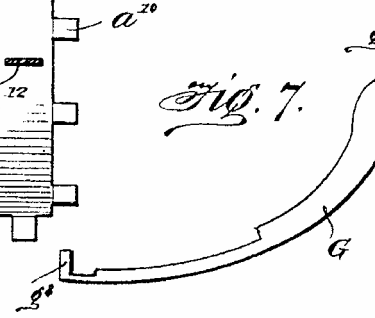

Fig. 7.

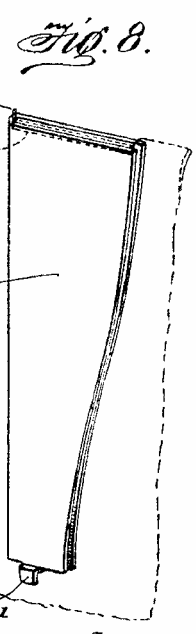

Fig. 8.

Witnesses
Trenton Velt,
Albert Popkins

Inventor
H. T. Kingsbury
 By *Stewart & Keeley*
 Attorneys

UNITED STATES PATENT OFFICE.

HARRY THAYER KINGSBURY, OF KEENE, NEW HAMPSHIRE.

TOY BANK.

SPECIFICATION forming part of Letters Patent No. 706,422, dated August 5, 1902.

Application filed September 21, 1901. Serial No. 110,180. (No model.)

To all whom it may concern:

Be it known that I, HARRY THAYER KINGSBURY, a citizen of the United States, residing at Keene, in the county of Cheshire, State of New Hampshire, have invented certain new and useful improvements in Self-Accounting Toy Banks, of which the following is a description, reference being had to the accompanying drawings and to the letters and figures of reference marked thereon.

The invention relates to that class of toy banks which are provided with registering mechanism.

The object of my invention is to provide a toy bank with an extremely simple and inexpensive registering mechanism which will register the amount of every deposit and expose to view the total amount contained in the bank. This object is accomplished by the mechanism shown in the accompanying drawings, in which—

Figure 1 is a front elevation of a toy bank provided with my improvements. Fig. 2 is a front elevation of the registering mechanism and its supporting devices removed, the dotted lines showing the position of the coin-actuated lever and latch upon the insertion of a coin-chute. Fig. 3 is a side elevation with the manually-operated latch-carrying plate swung outward with the latch in engagement with one of the rack-bars engaged and moved out thereby to rotate one of the registering wheels or disks. Fig. 4 is a horizontal section through the back of the bank and the manually-operated latch-carrying plate on line 4-4 of Fig. 2. Fig. 5 is a transverse vertical section on line 5-5, Fig. 2. Fig. 6 is a detail perspective of the latch for placing the manually-operated latch-carrying plate in operative relation to the rack-bars.

Fig. 7 is a detail view of one of said rack-bars; and Fig. 8 is a detail view of the coin-chute removed, together with its means of attachment.

A designates the bank, preferably formed of integral front and side sheet-metal plates *a* and *a'*, bottom *a²*, top *a³*, and back *a⁴*, united by means of slots or apertures *a⁵* and tongues *a⁶* after the manner common in sheet-metal boxes.

The coin-opening *a⁷* is preferably formed in the upper left-hand corner of the roof (see

Fig. 1) and therewith registers the upper open end of the coin-chute B. This coin-chute B is provided at the rear side of its upper end with a flange *b*, which is bent over and compressed upon the upper edge of the back *a⁴*; and the lower rear wall of the said chute is provided with a tongue *b¹*, which is passed through an aperture in the back *a⁴*, and then bent upon the outer face of the back, and so the coin-chute is firmly secured in place.

The left-hand side of the chute B is open and the chute gradually decreases in width from top to bottom, where it registers with a coin-opening *a⁸* in the horizontal partition A. This partition is provided at its rear edge with tongues *a⁹*, which engage slots or apertures in the back *a⁴*, and its other edges *a¹⁰*, are provided with a series of inclined fingers *a¹¹*, which engage the inner vertical side and front walls of the bank and steady the partition. The partition is further supported from the free ends of two parallel arms *A²*, *A³*, *A⁴*, *A⁵*, *A⁶*, *A⁷*, secured to the back *a⁴* by means of tongues and slots *a¹²* and connected at their opposite ends with the partition A' by means of standards *a¹³*. The back *a⁴*, partition A', arms *A²*, and standards *a¹³* constitute the framework or support for the registering mechanism to be presently described. By removing back plate *a⁴* all the mechanism will be removed with it for repairs, &c.

At the open curved side of the chute B is pivoted the coin-actuated lever C, the lower end of which extends down to the lower coin-opening *a⁸*, and this lever is moved away from the open side of the chute distances varying with the diameters of the coins.

D designates a manually-operated latch-carrying plate or arm hung by its upper ears *d¹* upon a pintle or rod *d²*, mounted on the frame-arms *A²*, *A³*, and pressed therebelow against the back plate *a⁴* by means of one depending arm of a spring D, coiled upon rod *d³*, with its other arm secured to one of the frame-arms *A²*.

E is a U-shaped hand-lever hung by its cross-arm in bearings between the back-plate *a⁴*, one of the arms *A²*, and one of the side plates *a⁴*, the longer arm *e* of said lever being exterior to the case and its inner shorter arm extending behind the lower end of the latch-

carrying plate D, so as to swing said arm or plate D forwardly against the action of the spring D.

F designates the pivoted latch or device which renders the registering mechanism operative upon the insertion of a coin, and it comprises an eccentric-like plate lying against the operating-arm D and having its lower edge provided with teeth to come into the path of shoulders *f¹*, *f²*, and *f³* on the respective rack-bars *G¹*, *G²*, which rack-bars, together with a third rack-bar *G³*, extend forwardly from the lower edge of the operating-arm D to the teeth *h* on the registering-wheels II, H', H².

The latch F is operated by a coin dropped into the chute B through the medium of a rod *c*, which connects it below and to the right of its axis to the lower end of the coin-lever C, the left-hand end of the rod *c* being merely bent at right angles, as at *c¹*, so as to extend behind and in the path of the coin-lever for operation thereby and yet not be positively connected to said coin-lever, and so the rod *c* will be allowed to move with the latch-carrying arm D. The rod *c* slides through an aperture in a lug or ear *d⁴* at the left-hand corner of the latch-carrying arm D. After operation by lever C and rod *c* the latch F is restored to its inactive position by means of the light spring *c²*, secured at its upper end to the arm D by means of lugs *d⁵* and at its free lower end engaging a lug *f⁴* on the upper edge of the latch. The coin-operated lever C is restored to its normal position by the spring *c³*.

When the latch F is moved to the left by a coin and its carrying-arm D is moved forwardly by the lever E to release the coin and bring the latch into engagement with the rack-bars *G¹*, *G²*, means must be provided for holding the latch in such operative position. This is accomplished as follows: I is a double-cranked arm having its left-hand crank *i* mounted in an aperture in the ear *d⁴*, and said arm extends thence along the face of the operating-arm D to the latch F, when it is bent rearwardly, and the crank *i* thus formed forms the axis of the latch, and, furthermore, passes through an aperture in latch-carrying arm D into contact with the back plate *a⁴* of the bank. This crank-arm I is pressed upon by the free end of the spring D, so that said spring will force it toward the arm D and latch F as soon as said arm D is moved away from the back plate *a⁴*, and when the carrying-arm D is returned to its normal position the crank *i* will strike the back plate *a⁴*, and move the arm I away from the carrying-arm D, and so the spring *d³* will restore the latch to its inactive position.

The lower edge of the latch-carrying arm D is bent rearwardly, as at *d⁶*, across the coin-outlet opening *a⁸* in order to hold the coin in the lower end of the chute B until the lever E has been operated to swing the latch-carrying plate toward the shoulders on the rack-

bars. The rear-ends of these rack-bars *G¹*, *G²* are bent at right angles to form shoulders *g¹* behind the lower edge of the swinging arm D, so that the rack-bars will be retracted by said arm, and the lower edge of the said arm is provided with vertical guide-slots *d⁷* for these rack-bars. The forward ends of the rack-bars *G¹*, *G²* are also bent to form shoulders *g²*, which lie in the path of pins or projections *h¹*, *h²* on the sides of the registering-wheels II, H', respectively. It is the units, wheel, H', the teeth, and H² the hundredths, said wheels being all numbered on their peripheries from "1" to "0" and exposed through an opening *A¹* in the front wall of the bank, and at every full revolution of one of these wheels its pin or projection *h¹* or *h²* will engage the shoulder *f¹* on the adjacent rack-bar and push the rack-bar the length of one tooth, and so effect the carrying in the usual manner. The rack-bars at their forward ends are guided in slots in a cross-bar *A²* between the arms *A²* and at their opposite ends are supported on the flange *d⁸* at the lower edge of arm D.

The registering-wheels are held in position by means of spring-pawls *k*, depending from a plate K in the forward ends of the frame-arms *A²*.

The operation is as follows, the parts being at rest and the registering-wheels all showing "0": If a cent is dropped into the chute, it will swing the lever C to the left, and with it the latch F, until the tooth I is brought over the rack-bar *G²* and into the path of the forward shoulder *f¹*, whereupon the lever E is operated to bring the carrying-arm D forwardly and bring the tooth I against shoulder *f¹*, whereupon the rack-bar *G²* will be carried forward one tooth and the numeral "1" will be exposed through the opening. Should eleven cents be successively dropped in, the last throw of the rack-bar *G²* will cause the pin *h²* on wheel H² to engage the lug or shoulder *g²* on rack-bar *G¹* and cause it to move the wheel H' one tooth, and so "01" will be exposed. Should a five-cent piece be dropped in, the tooth 2 will be brought into the path of the shoulder *f²* on rack-bar *G²* and the bar will be moved the distance of five teeth. A ten-cent piece will cause the tooth 4 to be brought into the path of the shoulder *f¹* of the tens rack-bar *G¹*, and said bar will move the wheel H' the distance of one tooth. When a twenty-five-cent piece is dropped in, the tooth 2 will be brought into the path of the shoulder *f²* to move the hundredths-wheel 3 will be brought into the path of the shoulder *f¹* of the tens-lever G to move it the distance of two teeth, this tooth 3 being bent forwardly far enough to move the bar G the distance of two teeth instead of one. The greater movement imparted to the latch F by a twenty-five-cent piece, whereby tooth 3 becomes operative and at the same time tooth 2 remains operative, is permitted by giving

a greater width to said tooth 2, as shown in Figs. 2 and 6. A fifty-cent piece will bring the tooth 2 into the path of the shoulder G' of the tens rack-bar G', and so the bar will be pushed the distance of five teeth and cause the tens-wheel H' to register accordingly. As soon as the carrying-arm moves outwardly with its latch the coin will be released and fall into the lower compartment of the bank, and the crank-arm I will be moved inwardly and retain the latch F in the position to which it was thrown by the coin until the carrying-arm D again assumes its normal position, when the cranked end *i* will cause the arm I to move away from the latch and release it. In order that coins may not be removed from the bank by inverting to cause them to return through the coin-chute, I provide a stop L, which is formed of an angle-shape piece pivoted at its bend to the back plate *o* adjacent to the inner end of the coin-opening *o* and having its arm *l* the heavier, so as to hold its arm *l* over the said opening, where the descending coins will depress it in passing.

The bottom of the bank is provided with an outlet-opening A' and a sliding door A'', which is secured in place by the screws A', which pass through the slots A''.

Having thus described my invention, what I claim, and desire to secure by Letters Patent, is—

1. The combination with a coin-actuated lever, and a registering mechanism, of a manually-operated latch-carrier, a latch carried thereby to connect the said carrier with the registering mechanism, and a connection between the coin-operated lever and said latch to throw it into its operative position; substantially as described.

2. The combination with a coin-actuated lever, and a registering mechanism including a plurality of registering wheels or disks and their operating rack-bars, of a manually-operated latch-carrier, a latch mounted on the said carrier and toothed for engagement with said rack-bars, and operative connections between the said coin-actuated lever and the latch to throw it and bring the proper teeth into operative relation to the rack-bars; substantially as described.

3. The combination of an open-sided coin-chute, and a coin-operated lever along the open side of the chute, a manually-operated latch-carrier; a latch mounted on said carrier, means for operating the latch from the coin-lever, of registering-wheels provided with shouldered operating-bars adapted to be connected with and thrown by the manually-operated carrier when its latch is thrown into operative position by a coin; substantially as described.

4. The combination with the tapered open-sided coin-chute, a coin-operated lever along the open side of the chute, and a registering mechanism including a plurality of registering-wheels provided with shouldered operat-

ing-bars, of a manually-operated carrier to swing along said operating-bars, a latch mounted on the carrier and toothed to engage said shouldered bars and connect the carrier therewith, and an operative connection between the coin-actuated lever and the latch for throwing it into its operative position; substantially as described.

5. The combination with the tapering coin-chute open at one side, a coin-operated lever along the open side of the slot for varying throw by coins of different diameter, and a registering mechanism including a plurality of registering-wheels and shouldered operating rack-bars, of a pivoted manually-operated latch-carrier mounted to swing along said rack-bars, a latch pivoted at the lower free end of the carrier and having graduated teeth on its lower edge, a rod for connecting said latch with the coin-actuated lever to swing the latch and bring the proper teeth into the path of the rack-bar shoulders and so connect said bars with the carrier; substantially as described.

6. The combination with the tapering coin-chute open at one side, a coin-operated lever along the open side of the slot for varying throw by coins of different diameter, and a registering mechanism including a plurality of registering-wheels and shouldered operating rack-bars, of a pivoted manually-operated latch-carrier crossing said rack-bars and movable along the same, a latch pivoted to the lower end of the said carrier with its lower edge provided with graduated teeth for engaging the shoulders on the rack-bars, a spring-pressed cranked arm pivoted on the said carrier with one of its cranks forming the pivot of the latch and extended through the carrier for engagement with the back plate to release the latch, and a rod extending from the plate and bent to pass behind the coin-lever for operation thereby; substantially as described.

7. The combination with an open-sided coin-chute, a lever along the open side of the chute, and a registering mechanism including registering-wheels provided with operating-bars, of a manually-operated carrier to swing along said bars and provided with a latch to connect it with the said bars, and a rod for connecting the latch with the coin-lever, the lower edge of the carrier having a flange to temporarily support the coin in the chute; substantially as described.

8. A toy bank comprising a body having a removable wall, a partition and framework secured to said wall, of an open-sided chute open end with a coin-inlet in the top and at its lower end registering with a coin-outlet in the partition, a lever along the open side of said chute, a registering mechanism mounted on said framework and including registering-wheels exposed through a front opening and provided with rack-bars, a forwardly-swinging latch-carrier pivoted at its upper

end to said removable wall and swinging over the rack-bars, a lever for operating said carrier from the exterior of the bank, a latch pivoted to the carrier and having a graduated toothed lower edge to engage the respective rack-bars and connect them to said carrier for operation thereby; and a rod for connecting the said latch with the coin-actuated lever; substantially as described.

9. The combination with the footed registering-wheels, and rack-bars for operating them, plus on the wheels, and lugs or shoulders on the rack-bars in the path of said pins, and a coin-controlled actuating mechanism for throwing the rack-bars; substantially as described.

10. The combination with a coin-actuated lever and a registering mechanism including toothed wheels, each having a pin and operating rack-bars, each having a shoulder at its forward end for engagement by the said pins and a retracting-shoulder at its rear end, of a forwardly-swinging manually-operated latch-carrier having slots at its lower end, receiving the rear shouldered ends of the rack-bars, a latch on the carrier having a graduated toothed lower edge to engage the rack-bars for forward throw by the carrier, and a rod for connecting the latch with the coin-actuated lever; substantially as described.

11. The combination with the registering-

wheels and their operating rack-bars, of a manually-operated latch-carrier extending over said bars and provided with a coin-actuated latch for operatively connecting it with the rack-bars; substantially as described.

12. The combination with the registering mechanism, provided with shouldered operating-bars, of a manually-operated latch-carrier extending over said bars and provided with a coin-actuated latch for operatively connecting it with said rack-bars, means for holding the latch in its operative position, and means for releasing the latch and restoring the same to its normal inactive position; substantially as described.

13. The combination with a manually-operated carrier or arm and a series of devices for operation by said carrier or arm, of a coin-operated latch mounted on said carrier or arm and provided with graduated teeth thrown into operative relation with one or more of said series of devices according to the distance the latch is moved by coins of different diameters; substantially as described.

In testimony whereof I affix my signature in presence of two witnesses.

HARRY THAYER KINGSBURY.

Witnesses:
W. L. MASON,
FRED P. BEEDLE.